



Panel Accessories

Make Panel Building Easy





PANEL ACCESSORIES

Get the job done! In addition to interconnect and automation products, WAGO offers a complete range of accessories designed to make panel building fast and easy. From small tasks, like wire preparation, to larger tasks such as marking and identifying all components in your control cabinet, we've got you covered. Our product range includes installation, cutting, stripping and crimping tools; test and measurement devices; as well as mounting and marking materials.

Find Your Solution

Operating Tools	4 - 5
Wire Cutting and Stripping	6 - 7
Crimping Tools	8 - 9
Cable cutting and Stripping	10 - 11
Ferrules	12 - 15
Test, Measurement Devices, Storage, and L-Boxx®s	16 - 17
DIN Rail and Cutters	18 - 21
Outlet Boxes & Bulkhead Interface Ports	22 - 23
Shield Connection System	24 - 25
Covers and Terminal Block Assemblies	26 - 27
Smart Designer	28 - 29
Marking and Labeling System	30-39

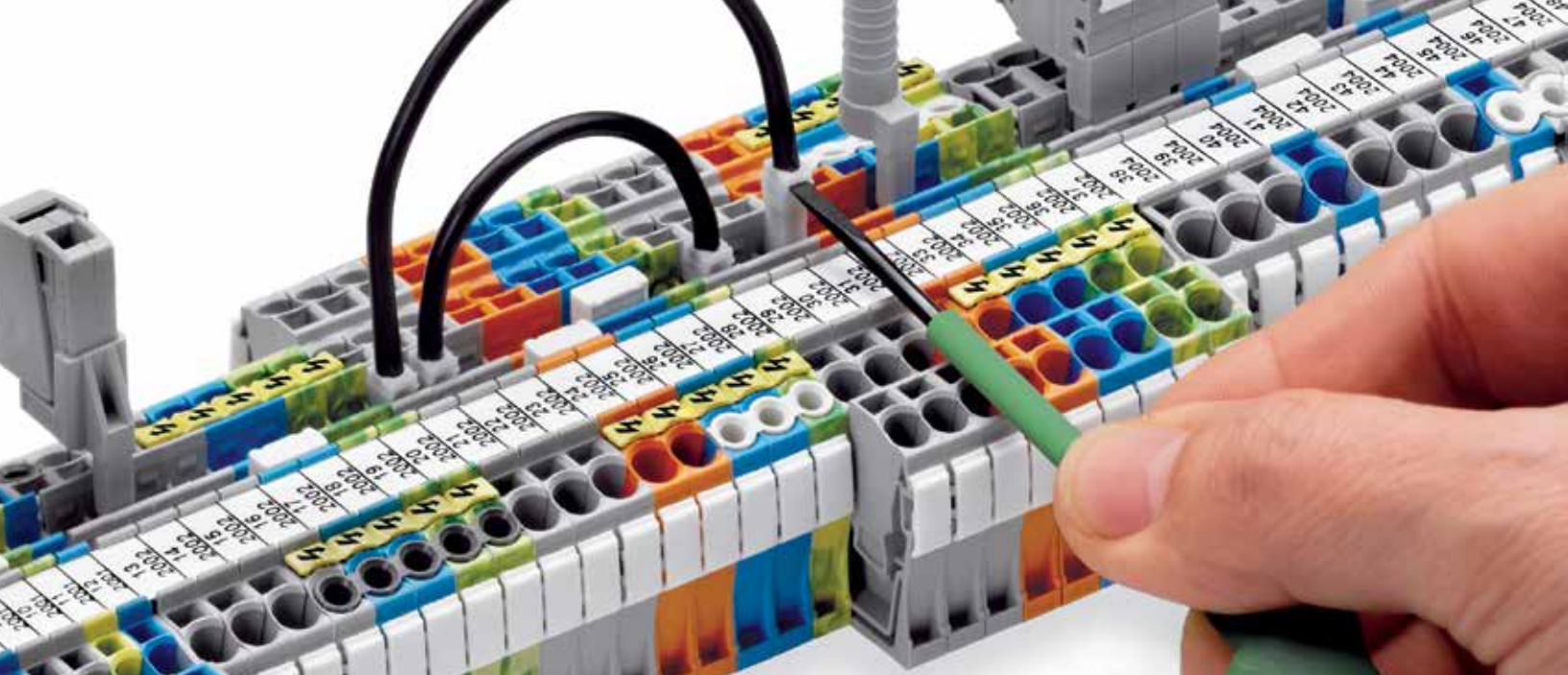

OPERATING TOOLS

The core technology of WAGO products is based upon our original, patented CAGE CLAMP® with no screws to torque down or ever re-tighten. The operation of the CAGE CLAMP® is simple – open the CAGE CLAMP® with the operating tool, which stays inserted so both hands are free to cut, strip, and insert the conductor. A variety of operating tools are available based upon the size and type of the terminal block or product that the wire is being connected to.



Operating tool stays inserted for hands-free wiring



Operating tool set

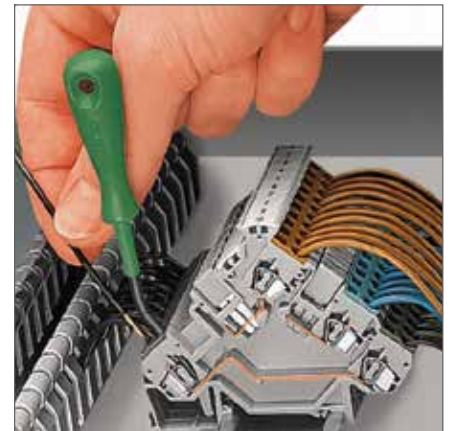

Angled operating tool for tight spaces

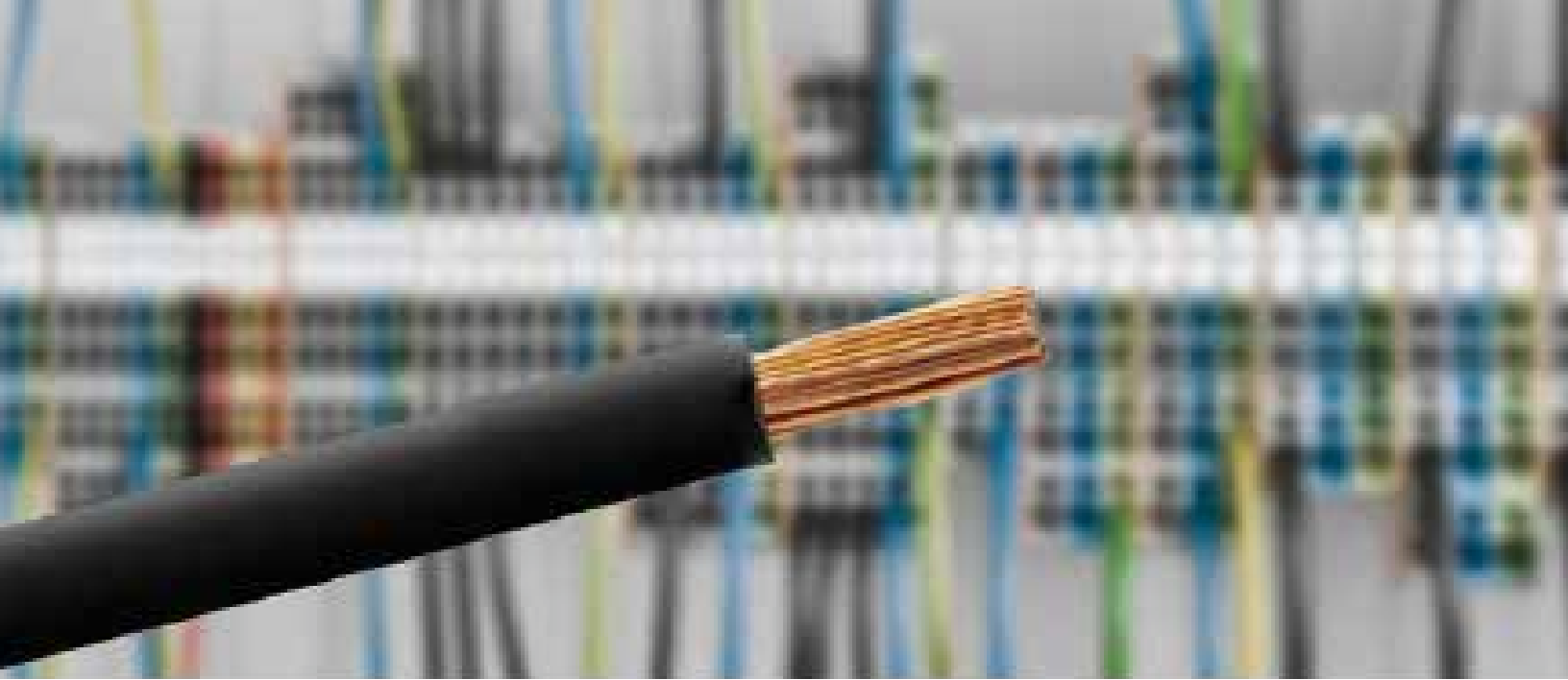

WIRE CUTTING AND STRIPPING

Wire cutting and stripping is an integral part of installation and having reliable, easy-to-use tools is vital. WAGO offers wire cutters that cut up to 2 AWG conductors and a large range of stripping tools for a variety of wire/cable sizes. Quickstrip tools save time, providing the ability to cut then strip to the desired length. Replacement blades are also available in varying sizes.



Automatic stripping
for control and sensor cables



Convenient, stackable, kit design



Intelligent bracket change system

Quickstrip Vario Stripper
Wire Stripper w/Integrated Cutter
32 ... 6 AWG

Replacement Blade Cassettes
for Quickstrip tools

Cable Stripper; Automatic



Item No.	Pack Unit	Item No.	Pack Unit	Item No.	Pack Unit
206-1125	1	Standard blade for Quickstrip 206-1125		For sensor wires; Ø .13"17"	
		206-1126	1	206-1481	1
		V blade (PTFE wire) for Quickstrip 206-1125		For control wires; Ø .17"28"	
		206-1127	1	206-1482	1
		Blade set for 206-1125, oval blade			
		206-1128	1		

Cable Knife Kit
Ø 0.16" ... 2.75"
includes all cable brackets in an L-boxx mini

Cable Knife
Ø 0.31" ... 1.10"
with intelligent bracket change system



Item No.	Pack Unit	Item No.	Pack Unit		
206-1400	1	206-1403	1		
		Spare Blade			
		206-1418	3		



CRIMPING TOOLS

The Variocrimp tools are the highest quality in the market. They produce a gas-tight crimp, both electrically and mechanically that leaves no room for oxidation between strands. The Variocrimp tools offer a consistent quality crimp – regardless of the user. Conductor and ferrule insertion is available from either side – accommodating both right and left-handed operators.



Self adjusting for wide wire range



Dedicated multi-slot crimping tool

Variocrimp 4 Crimping Tool
for insulated and uninsulated ferrules
Self adjusting from 24 - 12 AWG

Variocrimp 16 Crimping Tool
for insulated and uninsulated ferrules
Selectable for 10 - 6 AWG

Crimping Tool 25
for insulated and uninsulated ferrules
Dedicated crimp slot for 8, 6 and 4 AWG



Item No.	Pack Unit	Item No.	Pack Unit	Item No.	Pack Unit
Variocrimp 4 crimping tool		Variocrimp 16 crimping tool		Crimping tool 25	
206-1204	1	206-1216	1	206-1225	1

Crimping Tool 50
for insulated and uninsulated ferrules
Dedicated crimp slot for 2 AWG and 1/0



Item No.	Pack Unit		
Crimping tool 50			
206-1250	1		



CABLE CUTTING AND STRIPPING

Not all cables are the same! Having quality tools for different cable types is a major resource for installation. WAGO provides an intuitive offering of cable cutting and stripping solutions specific for common round cables, in-socket applications, or data cable. Ergonomic design and integrated functions allow each tool to be used safely and effectively.



Cable cutter for up to 2 AWG



Spiral cut cable stripper



Round cut cable stripper with adjustable strip depth

In-Socket Cable Stripper
 Ø .31"51"

Universal Cable and Wire Stripper
 Strip wire, knife for cable jacket, etc.
 Ø .31"51"
 24 - 12 AWG

Data Cable Stripper
 Ø .18"40"



Item No.	Pack Unit	Item No.	Pack Unit	Item No.	Pack Unit
206-1441	1	206-1442	1	206-1451	1

Cable Cutter
 for Cu & Al conductors up to 2 AWG



Item No.	Pack Unit		
206-118	1		



FERRULES

While ferrules aren't required with all WAGO products, we recognize many customers enjoy the added protection they offer. WAGO products with Push-in CAGE CLAMP® connection technology provide direct push-in of solid or ferruled conductors, saving installation time. WAGO offers both uninsulated and insulated ferrules. The insulated ferrules are also available as a twin ferrule, allowing you to connect two conductors into a single connection device.

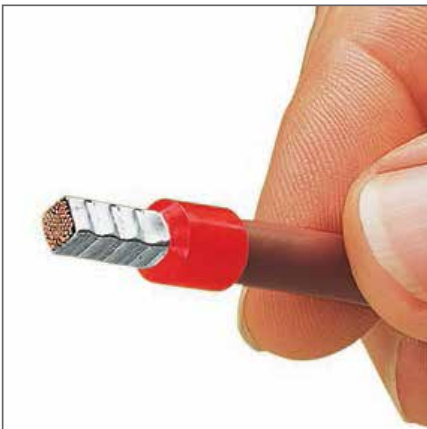

A perfect gas-tight crimp – both electrically and mechanically reliable

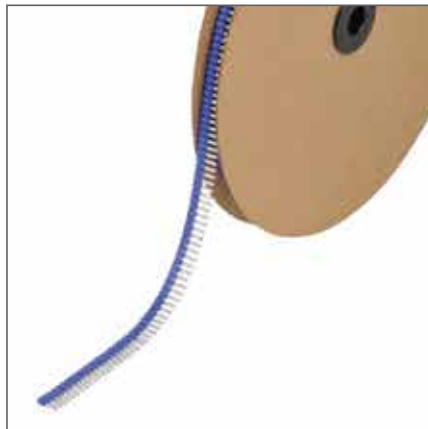

Insulated ferrules on a reel for use with automated machine



Twin ferrules for connecting two conductors

Insulated Ferrules

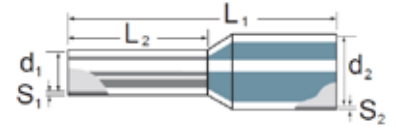

Ferrule Size			Ferrule Part No.	Color	Dimensions (in mm)						Minimum Order Quantity	Crimping Tool Part No.
mm ²	L ₂	AWG			L ₁	L ₂	D ₁	S ₁	D ₂	S ₂		
0.14	6	26	216-213	Gray	10	6	0.6	0.15	1.5	0.25	500	206-1204
0.14	8	26	216-218	Gray	12	8	0.6	0.15	1.5	0.25	500	206-1204
0.25	6	24	216-321	Yellow	10	6	0.85	0.15	1.8	0.25	1000	206-1204
0.25	8	24	216-301	Yellow	12	8	0.85	0.15	1.8	0.25	1000	206-1204
0.25	12	24	216-331	Light Blue	16	12	0.85	0.15	1.8	0.25	500	206-1204
0.34	6	22	216-322	Turquoise	10	6	0.85	0.15	2	0.25	1000	206-1204
0.34	8	22	216-302	Turquoise	12	8	0.85	0.15	2	0.25	1000	206-1204
0.34	12	22	216-260	Turquoise	14	12	0.85	0.15	2	0.25	1000	206-1204
0.50	6	20	216-221	White	12	6	1	0.15	2.6	0.25	1000	206-1204
0.50	8	20	216-201	White	14	8	1	0.15	2.6	0.25	1000	206-1204
0.50	10	20	216-241	White	16	10	1	0.15	2.6	0.25	1000	206-1204
0.75	6	18	216-222	Gray	12	6	1.2	0.15	2.8	0.25	1000	206-1204
0.75	8	18	216-202	Gray	14	8	1.2	0.15	2.8	0.25	1000	206-1204
0.75	10	18	216-242	Gray	16	10	1.2	0.15	2.8	0.25	1000	206-1204
0.75	12	18	216-262	Gray	18	12	1.2	0.15	2.8	0.25	1000	206-1204
1.00	6	18	216-223	Red	12	6	1.4	0.15	3	0.25	1000	206-1204
1.00	8	18	216-203	Red	14	8	1.4	0.15	3	0.25	1000	206-1204
1.00	10	18	216-243	Red	16	10	1.4	0.15	3	0.25	1000	206-1204
1.00	12	18	216-263	Red	18	12	1.4	0.15	3	0.25	1000	206-1204
1.50	6	16	216-224	Black	12	6	1.7	0.15	3.5	0.25	1000	206-1204
1.50	8	16	216-204	Black	14	8	1.7	0.15	3.5	0.25	1000	206-1204
1.50	10	16	216-244	Black	16	10	1.7	0.15	3.5	0.25	1000	206-1204
1.50	12	16	216-264	Black	18	12	1.7	0.15	3.5	0.25	1000	206-1204
1.50	18	16	216-284	Black	24	18	1.7	0.15	3.5	0.25	500	206-1204
2.08	8	14	216-205	Yellow	15	8	2.05	0.15	4.2	0.30	1000	206-1204
2.50	8	14	216-206	Blue	15	8	2.2	0.15	4.2	0.25	1000	206-1204
2.50	10	14	216-246	Blue	17	10	2.2	0.15	4.2	0.25	1000	206-1204
2.50	12	14	216-266	Blue	18	12	2.2	0.15	4.2	0.25	1000	206-1204
2.50	18	14	216-286	Blue	25	18	2.2	0.15	4.2	0.25	500	206-1204
4.00	10	12	216-207	Gray	18	10	2.8	0.2	4.8	0.30	500	206-1204
4.00	12	12	216-267	Gray	20	12	2.8	0.2	4.8	0.30	500	206-1204
4.00	18	12	216-287	Gray	26	18	2.8	0.2	4.8	0.30	100	206-1204
6.00	12	10	216-208	Yellow	20	12	3.5	0.2	6.3	0.30	100	206-1216
6.00	18	10	216-288	Yellow	26	18	3.5	0.2	6.3	0.30	100	206-1216
10.00	12	8	216-209	Red	22	12	4.5	0.2	7.6	0.40	100	206-1216
10.00	18	8	216-289	Red	28	18	4.5	0.2	7.6	0.40	100	206-1216
16.00	12	6	216-270	Blue	22	12	5.8	0.2	8.8	0.40	100	206-1216, 206-1225
16.00	18	6	216-210	Blue	28	18	5.8	0.2	8.8	0.40	100	206-1216, 206-1225
25.00	22	4	216-453	Yellow	36	22	7.3	0.2	11.2	0.40	50	206-1225
35.00	25	2	216-464	Red	39	25	8.3	0.2	12.7	0.40	50	206-1250
50.00	30	1	216-475	Blue	46	30	10.3	0.3	15	0.50	50	206-1250

Uninsulated Ferrules

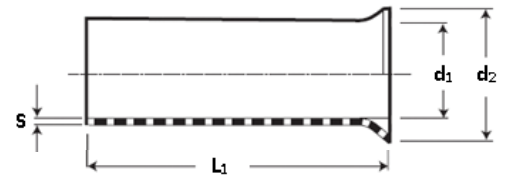

Ferrule Size			Ferrule Part No.	Dimensions (in mm)				Minimum Order Quantity	Crimping Tool Part No.
mm ²	L ₁	AWG		L ₁	D ₁	D ₂	S		
0.25	5	24	216-151	5	0.80	1.65	0.15	1000	206-1204
0.25	7	24	216-131	7	0.80	1.65	0.15	1000	206-1204
0.34	5	22	216-152	5	0.85	1.80	0.15	1000	206-1204
0.34	7	22	216-132	7	0.85	1.80	0.15	1000	206-1204
0.50	6	20	216-121	6	1.00	2.10	0.15	1000	206-1204
0.50	8	20	216-101	8	1.00	2.10	0.15	1000	206-1204
0.50	10	20	216-141	10	1.00	2.10	0.15	1000	206-1204
0.75	6	18	216-122	6	1.20	2.30	0.15	1000	206-1204
0.75	8	18	216-102	8	1.20	2.30	0.15	1000	206-1204
0.75	10	18	216-142	10	1.20	2.30	0.15	1000	206-1204
0.75	12	18	216-162	12	1.20	2.30	0.15	1000	206-1204
1.00	6	18	216-123	6	1.40	2.50	0.15	1000	206-1204
1.00	8	18	216-103	8	1.40	2.50	0.15	1000	206-1204
1.00	10	18	216-143	10	1.40	2.50	0.15	1000	206-1204
1.00	12	18	216-163	12	1.40	2.50	0.15	1000	206-1204
1.50	6	16	216-124	6	1.70	2.80	0.15	1000	206-1204
1.50	8	16	216-104	8	1.70	2.80	0.15	1000	206-1204
1.50	10	16	216-144	10	1.70	2.80	0.15	1000	206-1204
1.50	12	16	216-164	12	1.70	2.80	0.15	1000	206-1204
1.50	18	16	216-184	18	1.70	2.80	0.15	1000	206-1204
2.50	10	14	216-106	10	2.20	3.40	0.15	1000	206-1204
2.50	12	14	216-166	12	2.20	3.40	0.15	1000	206-1204
2.50	18	14	216-186	18	2.20	3.40	0.15	1000	206-1204
4.00	10	12	216-107	10	2.80	4.00	0.20	1000	206-1204
4.00	12	12	216-167	12	2.80	4.00	0.20	500	206-1204
4.00	18	12	216-187	18	2.80	4.00	0.20	500	206-1204
6.00	12	10	216-108	12	3.50	4.70	0.20	250	206-1216
6.00	18	10	216-188	18	3.50	4.70	0.20	500	206-1216
10.00	12	8	216-109	12	4.50	5.80	0.20	250	206-1216
10.00	18	8	216-189	18	4.50	5.80	0.20	250	206-1216
16.00	15	6	216-110	15	5.80	7.50	0.20	250	206-1216, 206-1225
16.00	18	6	216-190	18	5.80	7.50	0.20	250	206-1216, 206-1225
25.00	15	4	216-181	15	7.30	9.50	0.20	250	206-1225
25.00	25	4	216-413	25	7.30	9.50	0.20	250	206-1225
35.00	25	2	216-414	25	8.30	11.00	0.20	50	206-1250
35.00	30	2	216-424	30	8.30	11.00	0.20	50	206-1250
50.00	22	1	216-425	22	10.30	13.00	0.30	50	206-1250
50.00	32	1	216-435	32	10.30	13.00	0.30	50	206-1250

Insulated Ferrules on a Reel

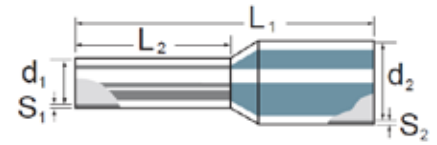

Ferrule Size			Ferrule Part No.	Color	Dimensions (in mm)						Reel Dia. in mm	Qty. on Reel
mm ²	L ₂	AWG			L ₁	L ₂	D ₁	S ₁	D ₂	S ₂		
0.50	8	20	216-201/001-000	White	14	8	1.00	0.15	2.60	0.25	320	5000
0.50	10	20	216-241/001-000	White	16	10	1.00	0.15	2.60	0.25	320	5000
0.75	8	18	216-202/001-000	Gray	14	8	1.20	0.15	2.80	0.25	320	5000
0.75	10	18	216-242/001-000	Gray	16	10	1.20	0.15	2.80	0.25	320	5000
1.00	8	18	216-203/001-000	Red	14	8	1.40	0.15	3.00	0.25	320	5000
1.00	10	18	216-243/001-000	Red	16	10	1.40	0.15	3.00	0.25	320	5000
1.50	8	16	216-204/001-000	Black	14	8	1.70	0.15	3.50	0.25	320	5000
1.50	10	16	216-244/001-000	Black	16	10	1.70	0.15	3.50	0.25	320	5000
2.50	8	14	216-206/001-000	Blue	15	8	2.20	0.15	4.20	0.25	320	3000
2.50	10	14	216-246/001-000	Blue	17	10	2.20	0.15	4.20	0.25	320	3000

Insulated Twin Ferrules

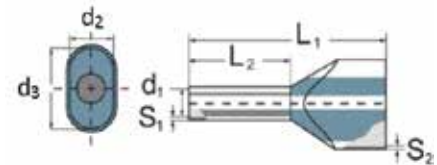

Ferrule Size			Ferrule Part No.	Color	Dimensions (in mm)							Minimum Order Quantity	Crimping Tool Part No.
mm ²	L ₂	AWG			L ₁	L ₂	D ₁	S ₁	S ₂	D ₃	D ₂		
2 x 0.34	8	2 x 22	216-1519	Turquoise	15	8	1.20	0.15	0.25	3.50	2.00	1000	206-1204
2 x 0.50	8	2 x 20	216-521	White	14	8	1.40	0.15	0.30	5.00	3.00	500	206-1204
2 x 0.50	10	2 x 20	216-1530	White	16	10	1.40	0.15	0.30	5.00	3.00	1000	206-1204
2 x 0.50	12	2 x 20	216-540	White	18	12	1.40	0.15	0.30	5.00	3.00	500	206-1204
2 x 0.75	8	2 x 18	216-523	Gray	14	8	1.70	0.15	0.30	5.50	3.00	500	206-1204
2 x 0.75	12	2 x 18	216-541	Gray	18	12	1.70	0.15	0.30	5.50	3.00	500	206-1204
2 x 0.75	18	2 x 18	216-571	Gray	24	18	1.70	0.15	0.30	5.50	3.00	500	206-1204
2 x 1.00	8	2 x 18	216-526	Red	15	8	2.00	0.15	0.30	5.80	3.20	500	206-1204
2 x 1.00	14	2 x 18	216-552	Red	21	14	2.00	0.15	0.30	5.80	3.20	500	206-1204
2 x 1.00	12	2 x 18	216-542	Red	19	12	2.00	0.15	0.30	5.80	3.20	500	206-1204
2 x 1.00	18	2 x 18	216-572	Red	25	18	2.00	0.15	0.30	5.80	3.20	500	206-1204
2 x 1.50	8	2 x 16	216-527	Black	16	8	2.20	0.15	0.30	6.50	3.60	500	206-1204
2 x 1.50	12	2 x 16	216-543	Black	26	12	2.20	0.15	0.30	6.50	3.60	500	206-1204
2 x 1.50	18	2 x 16	216-573	Black	20	18	2.20	0.15	0.30	6.50	3.60	100	206-1204
2 x 2.50	10	2 x 14	216-1535	Blue	19	10	2.80	0.15	0.40	8.00	4.50	500	206-1204
2 x 2.50	12	2 x 14	216-545	Blue	21	12	2.80	0.15	0.40	8.00	4.50	100	206-1204
2 x 2.50	18	2 x 14	216-575	Blue	27	18	2.80	0.15	0.40	8.00	4.50	100	206-1204
2 x 4.00	12	2 x 12	216-546	Gray	22	12	3.50	0.20	0.50	9.00	5.20	100	206-1216
2 x 4.00	18	2 x 12	216-576	Gray	28	18	3.50	0.20	0.50	9.00	5.20	100	206-1216
2 x 6.00	12	2 x 10	216-547	Yellow	23	12	4.50	0.20	0.50	11.4	6.20	100	206-1216
2 x 6.00	18	2 x 10	216-577	Yellow	29	18	4.50	0.20	0.50	11.4	6.20	100	206-1216
2 x 10.00	12	2 x 8	216-548	Red	24	12	5.80	0.20	0.50	13.4	7.60	100	206-1216
2 x 10.00	18	2 x 8	216-578	Red	30	18	5.80	0.20	0.50	13.4	7.60	100	206-1216
2 x 16.00	16	2 x 6	216-569	Blue	29	12	8.30	0.30	0.60	17.2	9.50	50	206-1250
2 x 16.00	25	2 x 6	216-599	Blue	38	18	8.30	0.30	0.60	17.2	9.60	50	206-1250



TEST AND MEASUREMENT DEVICES

WAGO devices are safe, compact and convenient for testing and/or measuring. AC and DC circuits can be safely and easily measured with these tools.



Testboy illuminates with voltage present

Testboy; Voltage Tester with integrated flashlight

Test Probes



Item No.	Pack Unit	Item No.	Pack Unit
206-804	1	206-912	1
• Voltage range: 12 - 1000 VAC		• 2mm Ø; 1000 V; CAT IV; 10 A	



STORAGE AND L-BOXX®S

With WAGO's large array of tools and accessories, we offer convenient storage options to help increase productivity. Our tool bags, paired with L-Boxx® kits, make organization even easier when heading to a jobsite.

<p>Strip and Crimp Tool Kit 260 x 155 x 63 mm box containing 206-1125 Quickstrip 4 and 206-1204 Variocrimp 4 tools</p>	<p>Ferrule Kit 260 x 155 x 63 mm box containing insulated ferrules: 1000 pcs of 20 AWG (216-241), 1000 pcs of 18 AWG (216-242), 1000 pcs of 18 AWG (216-243), 500 pcs of 16 AWG (216-264), 500 pcs of 14 AWG (216-266) and 400 pcs of 12 AWG (216-267)</p>	<p>WAGO Tool Bag for use with L-Boxx® Minis</p>
---	---	--



Strip and crimp tool kit		Ferrule Kit		WAGO Tool Bag	
60348435	1	60348433	1	206-3000	1
Empty box with dividers					
60348577	1				
Divider, long (max of 2 per box)					
412-887	1				
Divider, short (max of 3 per box)					
413-887	1				



DIN RAIL AND ACCESSORIES

Because WAGO offers a wide variety of interconnect and automation products that are mounted on DIN rail, we offer high-quality DIN rail in steel, copper, and aluminum. Standard DIN rail is available in 2 meter lengths as solid or slotted, and in 7.5 mm or 15 mm heights. In addition to a wide variety of DIN rail, we offer accessories such as DIN rail end caps, angled support brackets, end stops and DIN rail mount jumper carriers.



Solid, slotted or custom punched



Protective end cap, part no. 209-109, for 7.5 mm high DIN rail



DIN rail available in copper, steel, aluminum and plastic

DIN Rail, 2 m length
Steel: 35 mm (W), 7.5 mm (H), 1 mm (T)
Aluminum: 35 mm (W), 8.2 mm (H), 1.6 mm (T)
acc. to EN 60715

DIN Rail, 2 m length
Steel: 35 mm (W), 15 mm (H), 1.5 mm (T)
Copper: 35 mm (W), 15 mm (H), 2.3 mm (T)
Plastic: 35 mm (W), 15 mm (H), 2.3 mm (T)
acc. to EN 60715

Angled Support Bracket



Item No.	Pack Unit	Item No.	Pack Unit	Item No.	Pack Unit
Steel DIN rail, I _N 76 A		Steel DIN rail, I _N 125 A		Angled support bracket	
Solid 210-113	10	Solid 210-114	10	without screw 210-148	10
Hole width 25 mm; hole spacing 36 mm		Hole width 25 mm; hole spacing 36 mm		Screw M5 x 8 210-149	100 (5 x 20)
Slotted 210-112	10	Slotted 210-197	10		
Hole width 18 mm; hole spacing 25 mm					
Slotted 210-115	1	Copper DIN rail, I _N 309 A			
		Solid 210-198	10		
End Cap 209-109	25				
Aluminum DIN rail, 76A		Plastic DIN Rail,			
Solid 210-196	10	○ Gray 210-509	10		

(W) - Width (H) - Height (T) - Thickness

DIN Rail, 2 m length
Steel: 15 mm (W), 5.5 mm (H), 1 mm (T)
Aluminum: 15 mm (W), 5.5 mm (H), 1 mm (T)
acc. to EN 60715

DIN Rail Mount Jumper Holder

Screwless End Stop



Item No.	Pack Unit	Item No.	Pack Unit	Item No.	Pack Unit
Steel DIN rail, I _N 57 A		○ Gray 209-100	25	Screwless end stop, for DIN 15 rail, 6 mm wide	
Solid 210-295	1	for 279 - 284 series jumpers		○ Gray 249-101	25
Aluminum DIN rail, I _N 57 A		○ Gray 2009-180	25	Screwless end stop, for DIN 35 rail, 6 mm wide	
Solid 210-296	10	for 2000 to 2016 series jumpers		○ Gray 249-116	100
		○ Gray 282-369	25	Screwless end stop, for DIN 35 rail, 10 mm wide	
Slotted 210-111	1	for jumpers used with 282-811		○ Gray 249-117	50
Hole width 12 mm; hole spacing 20 mm		and 282-821 blocks		Screwless end stop, for DIN 35 rail, 14 mm wide	
				○ Gray 249-197	10

(W) - Width (H) - Height (T) - Thickness

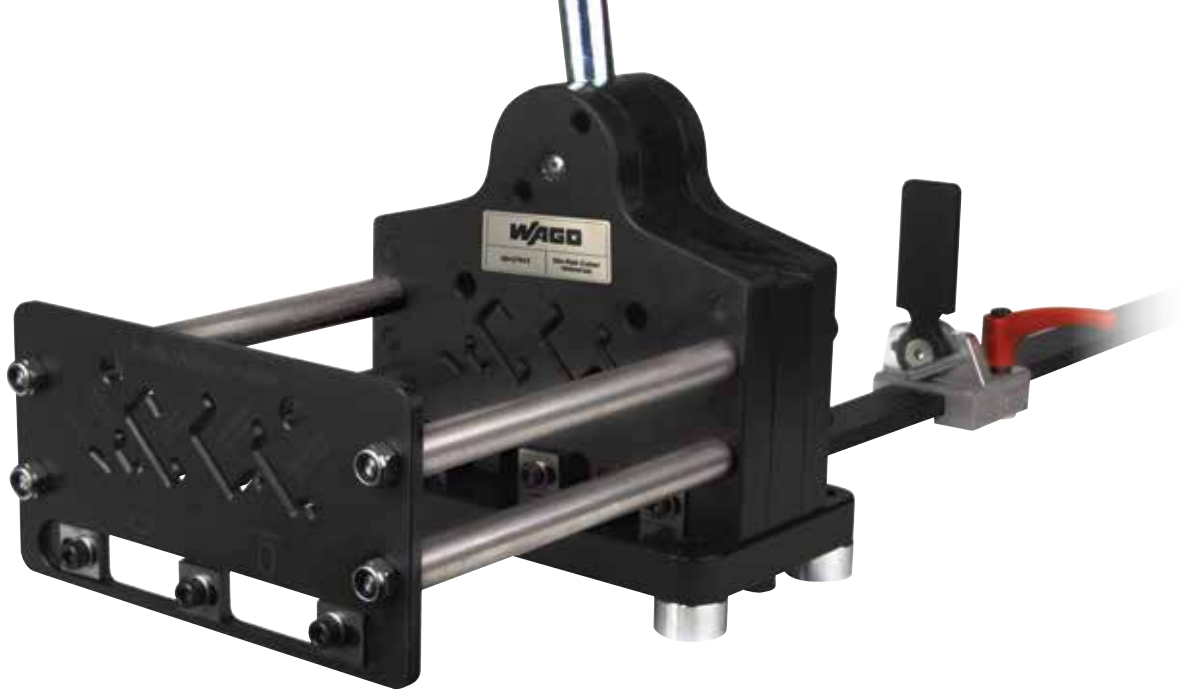

DIN RAIL AND WIRE DUCT CUTTING

In conjunction with the wide variety of DIN-rail options offered and as a complete solution, WAGO now gives users the ability to custom cut and punch both 7.5 mm and 15 mm Din-rail, with a basic and upgraded option available. The wire-duct cutter is a safe and user-friendly alternative to hand tools used for cutting wire channel.



Standard model is best option for standard size, slotted DIN rail



Universal model cuts and punches standard size DIN rail, mini rail, and busbar



Air/Hydraulic foot pedal available as upgrade to the Universal rail cutter

Standard DIN rail cutter
35 x 7.5; 35 x 15 mm
No punch



Item No.	Pack Unit
60448311	1

Universal DIN rail cutter
35 x 7.5; 35 x 15; 15 x 5; 35 x 7.5;
32 mm "G" DIN rail (mm)
Vertical and horizontal punch



Item No.	Pack Unit
60448310	1

Universal-H DIN rail cutter
(for use with air/hydraulic upgrade)
Same profile sizes as Universal



Item No.	Pack Unit
60448309	1

Air/Hydraulic foot pedal
For use with Universal-H DIN rail cutter



Item No.	Pack Unit
60448308	1

Wire duct cutter
Cuts 90° angle on wire duct
up to 5" / 127 mm wide



Item No.	Pack Unit
60448306	1

Wire duct cutter
Replacement blade



Item No.	Pack Unit
60448335	1



OUTLET BOXES AND BULKHEAD INTERFACE PORTS

Outlet boxes: Plug-in power is within reach with Convenient Power Outlets. The CPO Series allows power sources to be placed in the control cabinet for laptops, solder irons, test equipment, lighting, etc., where they are most useful. The CPO Series significantly reduces time, cost and frustration compared to the manual assembly of outlet boxes.

Bulkhead Interface Ports: Safely access high voltage panels with the Bulkhead Interface Ports. The BIP Series provides a secure gateway to your control cabinet, enabling you to plug-in to power and program without putting you or your operation at risk.



Power input terminal blocks with CAGE CLAMP® connection technology for fast, easy and maintenance-free wiring



Rugged all metal housing with metal on metal rolling spring clamp provides UL Type, 4, 4X, & 12 protection



Bulhead interface ports can be customized with your company's logo

Duplex Outlet
Rated voltage: 120 V

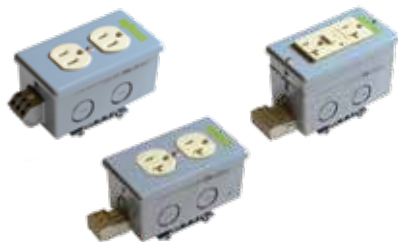

PCB Outlet with load terminals
Rated voltage: 125 V



Schuko
Rated voltage: 250 V



Item No.	Pack Unit	Item No.	Pack Unit	Item No.	Pack Unit
Rated current 15 A		Rated current 15 A		Rated current 15 A	
51017543	1	51015188	1	51012216	1
Rated current 15 A; GFCI		Rated current 5 A; fused; w/ red LED			
51018351	1	51198488	1		
Rated current 20 A					
51012218	1				

Bulkhead Interface Port
with Simplex Outlet

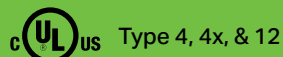

Bulkhead Interface Port
with Duplex Outlet



D-Sub Interface Connection
9-pin



Item No.	Pack Unit	Item No.	Pack Unit	Item No.	Pack Unit
with RJ45 connection		GFI; 3 A circuit breaker; 1 RJ45		D-Sub Interface Connection; 9-pin	
60342102	1	60342116	1	60342114	1
		GFI; 1 RJ45			
		60342118	1		
		3 A circuit breaker; 1 RJ45; 1 USB			
		60342108	1		

* Other options available. Consult Factory

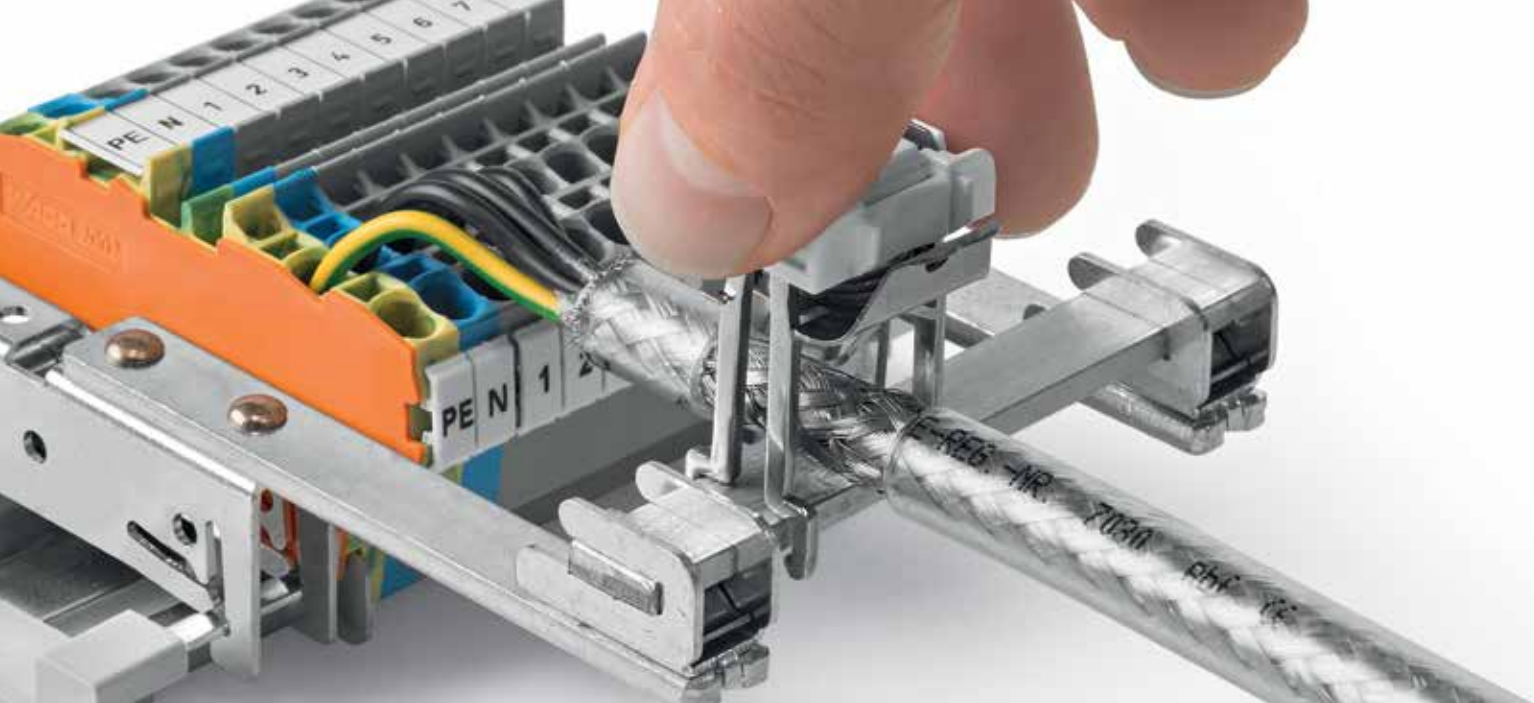

SHIELD CONNECTION SYSTEM

WAGO Shield Connection products assure that electrical noise and interference don't pass through and affect the performance of a control system. Vibration-proof and reliable, these shield clamps with latching springs can withstand up to 15 g with 4000 shocks per axis. WAGO offers a wide variety of shield clamps, saddles and carriers providing superior shielding as well as flexibility, depending upon the layout of the control cabinet.



Perforated panel mount bus bar



Busbar with DIN rail mount ground foot



U-shaped panel mount busbar

**Shield Clamping Saddle
with Latching Spring**



Shield Clamping Saddle



Item No.	Pack Unit	Item No.	Pack Unit
for 3-8 mm Ø Conductors		for up to 8 mm Ø Conductors	
790-208	50	790-108	50
for 5-16 mm Ø Conductors		for 7-16 mm Ø Conductors	
790-216	25	790-116	50
for 5-20 mm Ø Conductors		for 6-24 mm Ø Conductors	
790-220	25	790-124	50
		for 22-40 mm Ø Conductors	
		790-140	50

ACCESSORIES FOR SHIELD CLAMPING SADDLES

Busbar with DIN rail mount ground foot, parallel to rail	Busbar with DIN rail mount ground foot, 90° to rail	U-shaped busbar, Cu 10 x 3 mm, panel mount
15 mm long, Cu 10x3 mm	45 mm long, Cu 10x3 mm	A=63 mm, B=60 mm
790-110 25	790-113 25	790-190 25
25 mm long, Cu 10x3 mm	Busbar with 2 DIN rail mount ground feet	A=100 mm, B=60 mm
790-112 25	parallel to rail	790-191 25
45 mm long, Cu 10x3 mm	125 mm long, Cu 10x3 mm	A=63 mm, B=35 mm
790-114 25	790-115 25	790-192 25
		A=100 mm, B=35 mm
		790-193 25

Perforated busbar rail, panel mount	Spacer sleeve for busbar rail
1000 mm long	use with M5 screw
790-145 1	790-144 200

Carrier for busbar, DIN rail mount ground foot	Adjustable carrier for busbar, DIN rail mount ground foot, with T-connector	Busbar, Cu 10x3 mm
Single side, straight, x=70mm	B=56 mm, x=70 mm	1000 mm long
790-300 10	790-350/790-398 12	210-133 1
Single side, straight, x=80mm	B=99 mm, x=70 mm	50 mm long
790-302 10	790-352/790-398 12	790-134 20
Single side, angled, x=70mm	B=56 mm, x=85 mm	30 mm long
790-301 10	790-360/790-398 12	790-133 20
Both side, straight, x=70mm	B=99 mm, x=85 mm	
790-310 10	790-362/790-398 12	Insulated busbar carrier,
Both side, straight, x=80mm		panel mount
790-312 10	Insulated carrier for busbar,	with screw M4 x 8 mm
Both side, angled, x=70mm	DIN rail mount	790-100 50
790-311 10	790-400 20	with sheet metal screw
		790-101 50



COVERS FOR TERMINAL BLOCK ASSEMBLIES

WAGO's transparent covers for rail mounted terminal blocks add protection and security. The covers come in three sizes to accommodate different terminal blocks and can be customized to the length of the rail. Assembly is simple and fast using cover carriers that snap onto the DIN rail, then fasten with mounting screws. Insert a marking strip into the cover or print custom labels using the WAGO smartPRINTER. The optional locking mechanism secures the cover and protects against tampering.

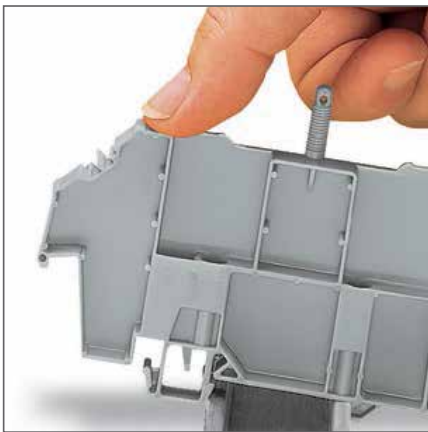

Easily snaps onto DIN rail

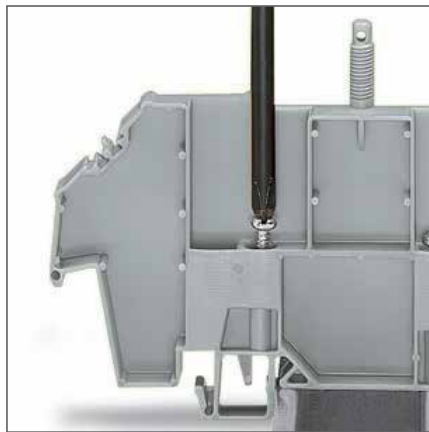

Secure on to rail by tightening screw



Secure cover onto carrier with nut.
Security seal can be added

Transparent cover, type 1
for rail-mounted terminal blocks



Transparent cover, type 2
for rail-mounted terminal blocks



Transparent cover, type 3
for rail-mounted terminal blocks



Item No.	Pack Unit	Item No.	Pack Unit	Item No.	Pack Unit
Cover, type 1, for DIN rail mount carrier type 1 1 m long		Cover, type 2, for DIN rail mount carrier type 2 1 m long		Cover, type 3, for DIN rail mount carrier type 3 1 m long	
○ Transparent 709-153	10	○ Transparent 709-154	10	○ Transparent 709-156	10

DIN rail mount carrier for transparent cover
used with 279, 280, 281, 282, 880, 264 and
270 Series terminal blocks

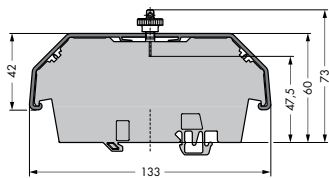

DIN rail mount carrier for transparent cover
used with 283 to 285 Series terminal blocks,
279 to 281 Series double- and triple-deck
terminal blocks, and 780 to 785 Series
TOPJOB® S terminal blocks

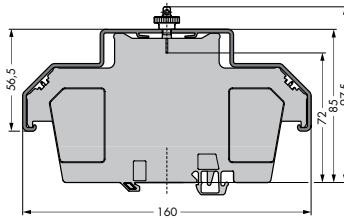

DIN rail mount carrier for transparent cover
used with 2000 to 2016 Series TOPJOB® S
terminal blocks and 2007 Series TOPJOB® S
transformer terminal blocks

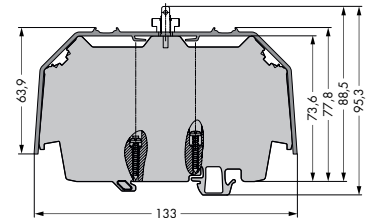

Item No.	Pack Unit	Item No.	Pack Unit	Item No.	Pack Unit
Cover carrier, type 1, with mounting and securing hardware		Cover carrier, type 2 with mounting and securing hardware		Cover carrier, type 3, with mounting and securing hardware	
○ Gray 709-167	10	○ Gray 709-168	10	○ Gray 709-169	10



SMART DESIGNER ONLINE

configurator.wago.com

The new Smart Designer online runs exclusively on a cloud server, ensuring that users will always have the most up-to-date version of the program. As a result, new WAGO components are available for use without needing a software update. The Smart Designer allows for the seamless progression of a project through planning, documenting, building and labeling.

Benefits:

- No installation
- No updating
- Accessible anywhere
- Newest WAGO components available immediately
- Free

CONCEPT



RESEARCH

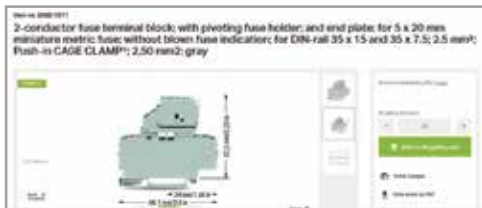

- WAGO website allows you to find the WAGO product to fit your needs
- Easy to find technical data and component specifications
- Customizable libraries for sorting commonly used components
- Add your own part numbers that follow parts through the design process

DESIGN

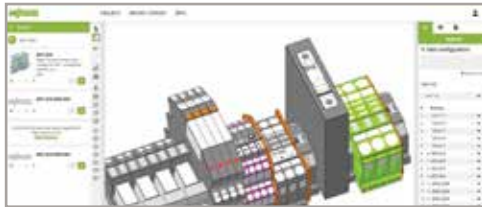

- Create your assembly to your specifications
- Program shows viable accessories that work with components in the project
- Generate parts list with product images
- Add custom labels that can be sent directly to a WAGO Smart Printer
- Program checks your design for safety and functional build errors

BUILD

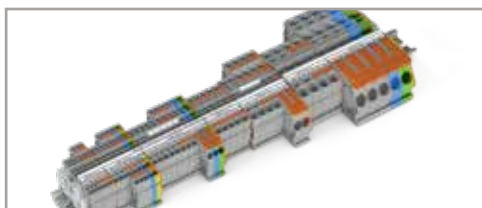

- Customizable project print out with multiple views and information
- Immediately print labels using WAGO Smart Printer
- Export projects in numerous CAD formats for **future design**
- Send project directly to WAGO to build

CONFIGURATOR.WAGO.COM

CAD EXPORT

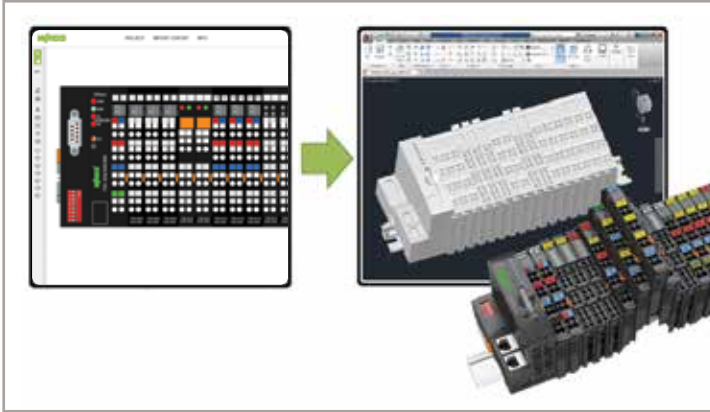

- Smart Designer can export your project as a detailed CAD drawing ready to be inserted into further project designs
- Program generates 2D and 3D models
- Exports in commonly used neutral and proprietary CAD formats such as STEP, IGES, DXF, DWG, Inventor, NX, and SolidWorks Visual Basic files

CAE INTERFACES

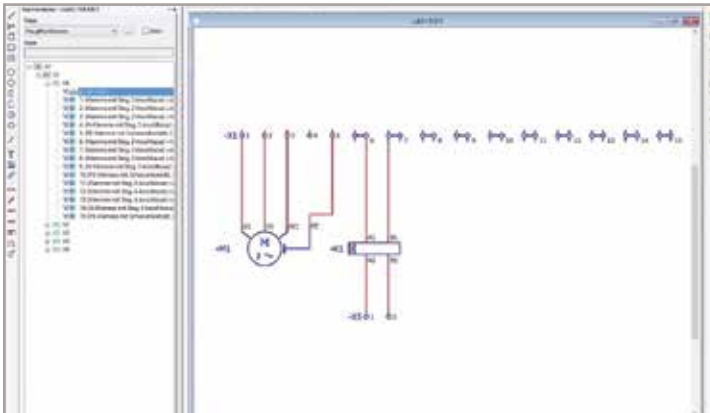

- Various interfaces for electrical design programs such as EPLAN and WSCAD are available
- Projects can be exported from your design software directly into Smart Designer to check for build errors, and then reimported back into your original program
- WAGO labels can then be printed from the electrical design program right to the WAGO Smart Printer

LABELING WITH SMARTSCRIPT

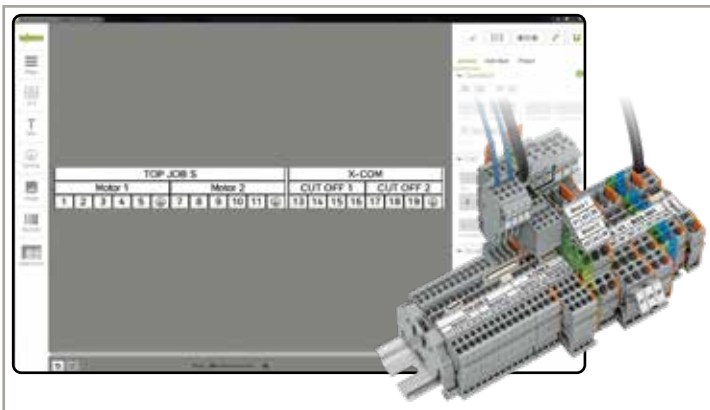

- Smart Script is a locally installed labeling program that can be used without an internet connection
- Seamlessly export labels created in Smart Designer Online directly into Smart Script
- Create labels using the full range of WAGO marking products
- Direct output to the WAGO Smart Printer

Access the Smart Designer at configurator.wago.com and view an interactive tutorial at configurator.wago.com/help

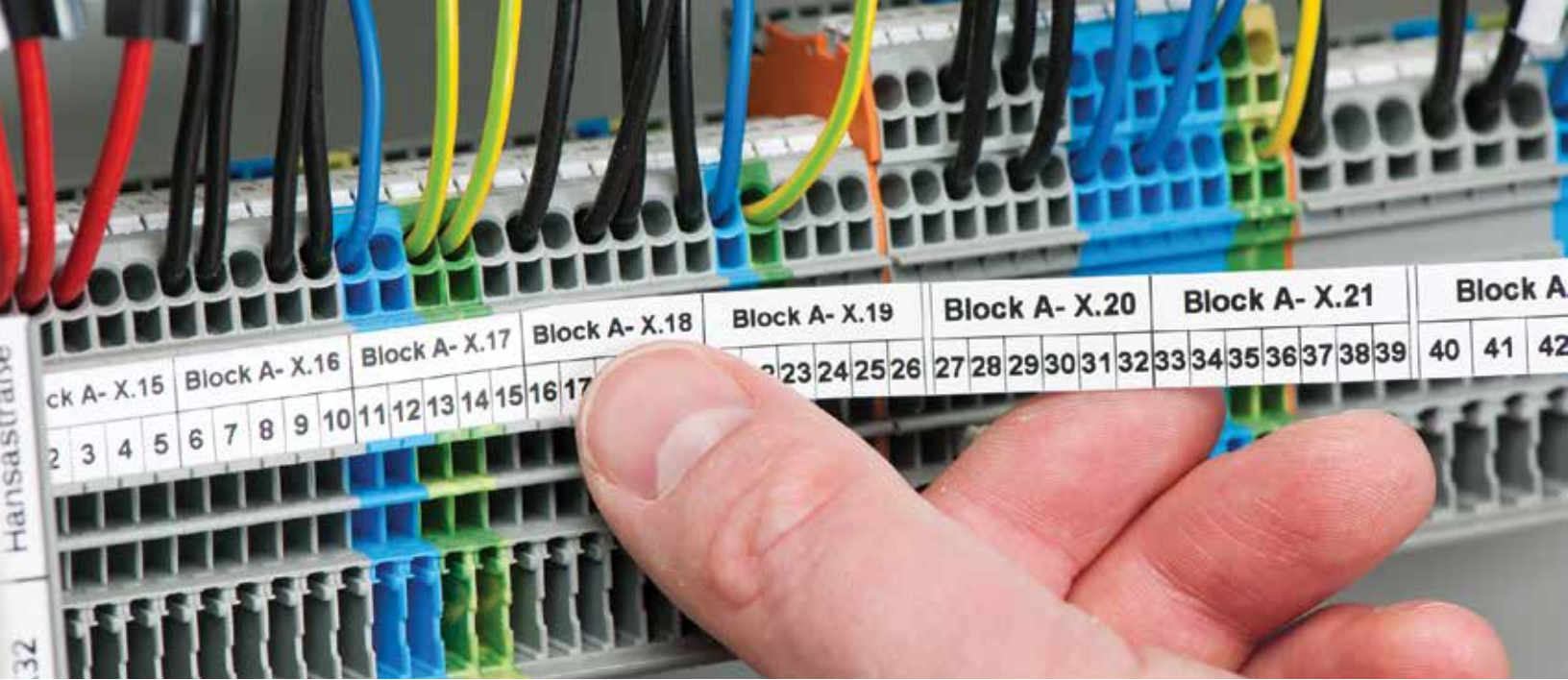

CLEARLY MARK CONTROL CABINETS

The Smart Printer is the industry's most versatile yet economical printer. Not only mark terminal blocks, relays, power supplies, and PLC's, but also quickly switch out the roll of material and mark control cabinet type plates, push-buttons, wire markers, and more.

Smart Designer offers free online configuration and ordering of all electrical interconnect and automation components in full 3D. Create and save custom assemblies, with all accessories and marking, before exporting into all standard CAD formats.

www.wago.com/smartdesigner

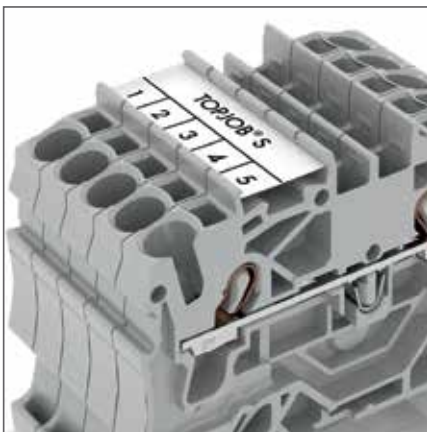

Industry exclusive continuous marker strip for terminal blocks



Cable and conductor marking

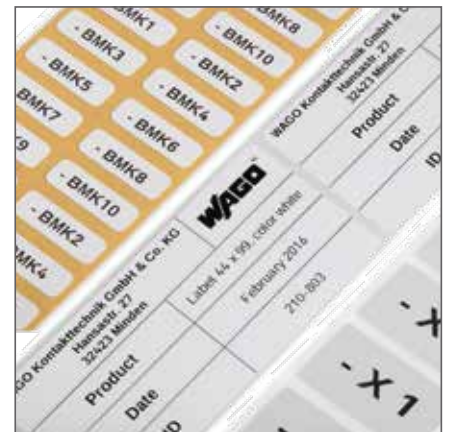

Device marking

SAVE MONEY WITH SMART PRINTER

Universal Marking Solution



Smart Printer
Item No. 258-5108
without marking material



Smart Printer
Item No. 258-5107

Cost-Effective Marking

- Industry's most affordable printing solution
- Lower material costs
- Reduce marking time
- Minimal maintenance

Universal

- For any control cabinet marking application
- Mark all WAGO terminal blocks and label conductors/cables and devices

Easy to Use

- Generate all marking data directly via Smart Script marking software

Easy Installation

- Installation package and marking software are available at www.wago.com/smartprinter

Smart Printer Includes:

- Power supply and cable
- USB cable
- 1x marking strip reel (2009-110)
- 1x WMB Inline marking reel (2009-115)
- 2x roller (258-5006 + -5007)
- 1x reel holder
- 1x ink ribbon (258-5005)

Accessories



258-5030* Cutter
Attachment for
Smart Printer



Carrying case
for Smart Printer
Item No. 258-5015
Dimensions (cm):
50 W x 26 H x 33 D



Ink ribbon, standard
Item No. 258-5005



Ink ribbon
for self-laminating labels
& heat shrink
Item No. 258-5014

TERMINAL BLOCK MARKING

Marking Strips















WMB Inline Markers on a Roll



Item No.	Width/Color	Pack. Unit
2009-110	11 mm, white	1 roll (50 m)
2009-110/020-002	11 mm, yellow	1 roll (50 m)
709-177	7.5 mm, translucent	1 roll (50 m)
709-178	7.5 mm, white	1 roll (50 m)
757-901/000-050	10 mm, white	1 roll (50 m)

Item No.	Description	Pack. Unit
2009-113	WMB Inline, white, 3.5 mm stretchable	1 roll (2,300 markers)
2009-114	WMB Inline, white, 4 mm stretchable	1 roll (2,000 markers)
2009-115	WMB Inline, white, 5 mm stretchable	1 roll (1,500 markers)
2009-145	Mini-WSB Inline, white, 5 mm stretchable	1 roll (1,700 markers)
2009-515	WMB Inline for Phoenix Contact terminal blocks, white, 5 mm stretchable	1 roll (900 markers) replaces UC-TM5 and ZB5 markers
2009-615	WMB Inline for Weidmüller terminal blocks, white, 5 mm stretchable	1 roll (1,200 markers) replaces WS 10/5 marker

INLINE MARKERS AND ROLLERS

Description	Compatible with Series	Color (Marker)	Item No. (Marker)	Roller	Item No. (Roller)
Marking strips, cable and conductor markers, device labels 	Pages 30-31	-	see Page 28 with exception of Weidmuller and Phoenix markers	 ● black	258-5006
WMB Inline, 3.5 mm stretchable 	Pages 30-31	○ white ● yellow ● red ● blue ● gray ● orange ● light green ● green ● violet	2009-113 2009-113/000-002 2009-113/000-005 2009-113/000-006 2009-113/000-007 2009-113/000-012 2009-113/000-017 2009-113/000-023 2009-113/000-024	 ● green	258-5007
WMB Inline, 4 mm stretchable 	Pages 30-31	○ white ● yellow ● red ● blue ● gray ● orange ● light green ● green ● violet	2009-114 2009-114/000-002 2009-114/000-005 2009-114/000-006 2009-114/000-007 2009-114/000-012 2009-114/000-017 2009-114/000-023 2009-114/000-024	 ● green	258-5007
WMB Inline, 5 mm stretchable 	Pages 30-31	○ white ● yellow ● red ● blue ● gray ● orange ● light green ● green ● violet	2009-115 2009-115/000-002 2009-115/000-005 2009-115/000-006 2009-115/000-007 2009-115/000-012 2009-115/000-017 2009-115/000-023 2009-115/000-024	 ● green	258-5007
Mini-WSB Inline, plain, 5 mm stretchable 	Pages 30-31	○ white ● yellow ● red ● blue ● orange ● green	2009-145 2009-145/000-002 2009-145/000-005 2009-145/000-006 2009-145/000-012 2009-145/000-023	 ● blue	258-5008
WMB Inline for Phoenix Contact terminal blocks, 5 mm stretchable, replaces UC-TM5 and ZB5 		○ white	2009-515	 ○ white	258-5009
WMB Inline for Weidmüller terminal blocks, 5 mm stretchable, replaces WS 10/5 		○ white	2009-615	 ● red	258-5010

SELECTION MATRIX

Marking Accessories and Appropriate Product Series

	Marking strips	WMB Inline markers on a roll	WMB Inline markers, cards	Mini-WSB roll	Mini-WSB card	Self-adhesive marking strips	Direct marking on product
	709-177 7.5 mm	2009-113 3.5 mm	793-3501 3.5 mm	2009-145 5 mm	2009-110 11 mm		
	709-178 7.5 mm	2009-114 4 mm	793-4501 4 mm	248-501 5 mm			
	2009-110 11 mm	2009-115 5 mm	793-5501 5 mm				
TOPJOB® S Rail Mounted Terminal Blocks							
2000, 2200 Series							
2001, 2201 Series							
2002, 2102, 2202 Series							
2003 Series							
2004, 2204 Series							
2005 Series							
2006, 2106, 2206 Series							
2007 Series							
2010, 2210 Series							
2016, 2116, 2216 Series							
"Classic" Rail Mounted Terminal Blocks							
270 Series							
279 Series							
280 Series							
281 Series							
282 Series							
283 Series							
284 Series							
285 Series							
880 Series							
TOPJOB® Classic							
780 Series							
781 Series							
782 Series							
783 Series							
784 Series							
785 Series							
X-COM®-SYSTEM/X-COM®S-SYSTEM							
X-COM® 769 Series							
X-COM® 870 Series							
X-COM® S MINI 2020 Series							
X-COM® 2022 Series							
Miniature Terminal Blocks							
260 Series							
261 Series							
262 Series							
264 Series							
862 Series							
869 Series							

■ Label using Smart Printer

■ Order pre-labeled from WAGO

	Marking strips	WMB Inline markers on a roll	WMB Inline markers, cards	Mini-WSB roll	Mini-WSB card	Self-adhesive marking strips	Direct marking on product
Patchboard Systems 727 Series	7.5 mm 709-177 7.5 mm 709-178	3.5 mm 2009-113	3.5 mm 793-3501	5 mm 2009-145	5 mm 248-501		
High-Current Terminal Blocks, POWER CAGE CLAMP 285 Series		4 mm 2009-114	4 mm 793-4501				
PCB Terminal Blocks 745 Series		5 mm 2009-115	5 mm 793-5501				
218, 233, 234, 235, 236, 243, 250, 252, 253, 254, 255, 256, 257, 735, 736, 737, 738, 739, 740, 741, 742, 804, 805, 806, 816, 2624, 2626, 2636, 2604, 2606, 2616, 2706 and 2716 Series							
WAGO-I/O-SYSTEM 750 Series 753 Series							
INTERFACE Modules 788 Series 857 Series 858 Series 859 Series							
WINSTA® 770 Series 890 Series							
MULTI CONNECTION SYSTEM 746 Series							
231, 232, 713, 714, 721, 722, 733, 734, 831, 832, 2231, 2721 Series							
picoMAX® 2091, 2092 Series							

CABLE AND CONDUCTOR MARKING

Marking Sleeves and Markers



Length: 12 mm

Item No.	Description and Color	Pack. Unit
211-812	Marking sleeve for 24 - 10 AWG wire diameter, transparent	1 bag (500 sleeves)
211-813	Marking sleeve for 8 - 2 AWG wire diameter, transparent	1 bag (500 sleeves)
211-811	Marker for marking sleeve 12 x 4 mm, white	1 roll (2,500 markers)

Length: 23 mm

Item No.	Description and Color	Pack. Unit
211-823	Marking sleeve for 24 - 10 AWG wire diameter, transparent	1 bag (500 sleeves)
211-824	Marking sleeve for 8 - 2 AWG wire diameter, transparent	1 bag (200 sleeves)
211-829	Marking sleeve Mounting via cable tie, transparent	1 bag (200 sleeves)
211-821	Marker for marking sleeve 23 x 4 mm, white	1 roll (2,500 markers)

Cable Tie Markers



Item No.	Description and Color	Pack. Unit
211-835	Cable tie marker 25 x 20 mm (write-on surface: 25 x 10 mm), white	1 roll (500 markers)
211-835/ 000-002	Cable tie marker 25 x 20 mm (write-on surface: 25 x 10 mm), yellow	1 roll (500 markers)
211-835/ 000-005	Cable tie marker 25 x 20 mm (write-on surface: 25 x 10 mm), red	1 roll (500 markers)
211-836*	Cable tie marker 117.5 x 15 mm (write-on surface: 100 x 15 mm), white	1 roll (800 markers)
211-836/ 000-002	Cable tie marker 117.5 x 15 mm (write-on surface: 100 x 15 mm), yellow	1 roll (800 markers)
211-836/ 000-005	Cable tie marker 117.5 x 15 mm (write-on surface: 100 x 15 mm), red	1 roll (800 markers)
211-837	Cable tie marker 44 x 10 mm marking surface, white	1 roll (500 markers)
211-837/ 000-005	Cable tie marker 44 x 10 mm marking surface, yellow	1 roll (500 markers)
807-0090/ 0101-0100	Suitable cable ties	1 bag (25 ties)

*available in additional colors (yellow-green, blue, orange) - see website for details

Thread-On Wire Markers



Item No.	Description and Color	Pack. Unit
211-861	Thread-on Markers 5 x 10.5 mm write-on surface, 30 - 26 AWG, white	1 roll (1,000 markers)
211-862	Thread-on Markers 7 x 10.5 mm write-on surface, 24 - 18 AWG, white	1 roll (1,000 markers)
211-863	Thread-on Markers 10 x 17 mm write-on surface, 16 - 10 AWG, white	1 roll (1,000 markers)

Self-Laminating Labels



Item No.	Description and Color	Pack. Unit
211-855	Self-laminating labels 9 x 18 mm write-on surface, white	1 roll (1,000 labels)
211-856	Self-laminating labels 15 x 12 mm write-on surface, white	1 roll (1,000 labels)
211-857	Self-laminating labels 18 x 44 mm write-on surface, white	1 roll (500 labels)

*Requires alt. ink ribbon 258-5014

Shrink Tubing (3:1 Shrink Ratio)



Item No.	Size	Recommended Diameter	Pack. Unit
60418068	1/8", White	24 - 18 AWG	1 roll (100 ft)
51227742	1/8", Yellow	24 - 18 AWG	1 roll (100 ft)
51223871	3/16", White	16 - 12 AWG	1 roll (100 ft)
51227743	3/16", Yellow	16 - 12 AWG	1 roll (100 ft)
60387715	1/4", White	12 - 8 AWG	1 roll (100 ft)
51227744	1/4", Yellow	12 - 8 AWG	1 roll (100 ft)
60483195	1/2", White	6 - 1/0 AWG	1 roll (100 ft)

*Requires alt. ink ribbon 258-5014

DEVICE MARKING

Self-Adhesive Continuous Labels



Item No.	Description and Color	Pack. Unit
210-831	9 lines, 2.3 mm wide, white	1 roll (25 m)
210-832	9 lines, 3 mm wide, white	1 roll (25 m)
210-834	5 lines, 5 mm wide, white	1 roll (25 m)
210-833	5 lines, 6 mm wide, white	1 roll (25 m)

Self-Adhesive Marking Strips



Item No.	Description and Color	Pack. Unit
210-702	15 mm wide, white	1 roll (50 m)
210-870	10 mm wide, white	1 roll (20 m)
210-871	10 mm wide, silver	1 roll (20 m)
210-872	20 mm wide, white	1 roll (20 m)
210-873	20 mm wide, silver	1 roll (20 m)
210-874	30 mm wide, white	1 roll (20 m)
210-875	30 mm wide, silver	1 roll (20 m)
210-876	46 mm wide, white	1 roll (20 m)
210-876/000-002	46 mm wide, yellow	1 roll (20 m)
210-877	46 mm wide, silver	1 roll (20 m)

Self-Adhesive Polyester Labels



Item No.	Description and Color	Pack. Unit
210-805	6 x 15 mm, white	1 roll (3,000 labels)
210-805/000-002	6 x 15 mm, yellow	1 roll (3,000 labels)
210-806	9 x 15 mm, white	1 roll (3,000 labels)
210-806/000-002	9 x 15 mm, yellow	1 roll (3,000 labels)
210-807	8 x 20 mm, white	1 roll (3,000 labels)
210-807/000-002	8 x 20 mm, yellow	1 roll (3,000 labels)
210-808	9.5 x 25 mm, white	1 roll (1,500 labels)
210-810	5 x 35 mm, white	1 roll (1,500 labels)

Self-Adhesive Fabric Labels



Item No.	Description and Color	Pack. Unit
210-811	7 x 20 mm, 1 line, white	1 roll (3,000 labels)
210-811/000-002	7 x 20 mm, 1 lines, yellow	1 roll (3,000 labels)

Push-Button Markers



Item No. (Push-Button Marker)	Size	Pack. Unit	Color/Other	Accessories for Push-Button Markers	Pack. Unit
210-850*	26.5 x 18.0 mm	1 roll (1,000 markers)	silver, detachable adhesive	210-851 Cover, transparent	100 covers
210-856**	27.5 x 17.5 mm	1 roll (1,000 markers)	silver, detachable adhesive	210-857 Cover, transparent	100 covers
210-858**	22.0 x 22.0 mm	1 roll (1,000 markers)	silver, permanent adhesive	210-859 Cover, transparent	100 covers
210-860**	27.0 x 27.0 mm	1 roll (1,000 markers)	silver, permanent adhesive	210-861 Cover, transparent	100 covers
210-862**	27.0 x 12.5 mm	1 roll (1,000 markers)	silver, permanent adhesive	210-863 Cover, transparent	100 covers
210-852	27.0 x 19.0 mm	1 roll (350 markers)	silver, permanent adhesive	210-853 Frame for 22.5 mm Push-buttons, Black	100 frames
210-855	27.0 x 18.0 mm	1 roll (350 markers)	silver, permanent adhesive	-	-
210-854	28.0 x 28.0 mm	1 roll (500 markers)	silver, permanent adhesive	-	-
210-847	22.0 x 22.0 mm	1 roll (300 markers)	silver, permanent adhesive	-	-
210-848	27.0 x 27.0 mm	1 roll (250 markers)	silver, permanent adhesive	-	-

* For Eaton ** For Siemens

Type Plates



Item No.	Description and Color	Pack. Unit
210-801	33 x 70 mm, white	1 roll (500 plates)
210-802	33 x 70 mm, silver	1 roll (500 plates)
210-803	44 x 99 mm, white	1 roll (500 plates)
210-804	44 x 99 mm, silver	1 roll (500 plates)
210-812	25 x 50 mm, silver	1 roll (500 plates)

Void/Tamper-Proof Label



Item No.	Description and Color	Pack. Unit
210-824	44 x 99 mm, silver	1 roll (300 labels)

WAGO Corporation
N120 W19129 Freistadt Road
Germantown, Wisconsin 53022
Telephone: 800 / DIN-Rail (346-7245)
Fax: 262 / 255-3232
info.us@wago.com
www.wago.us

WAGO Canada Inc.
4145 North Service Rd., Unit 224
Burlington, ON
L7L 6A3
Telephone: 888 / WAGO 221 (924-6221)
info.ca@wago.com
www.wago.ca

WAGO SA DE CV
Carretera estatal 431 Km. 2+200. Lote 99 6
Parque Industrial Tecnológico Innovación Querétaro
El Marques, Qro. 76246
Lada sin Costo: 01 800 288 WAGO (288-9246)
Telefono: 422 / 221-5946
info.mx@wago.com
www.wago.mx

WAGO is a registered trademark of WAGO Verwaltungsgesellschaft mbH.

"Copyright – WAGO Kontakttechnik GmbH & Co. KG – all rights reserved. The content and structure of the WAGO Websites, catalogs, videos, and other WAGO media are subject to copyright. The dissemination or changing of the content of these pages and videos is not permitted. Furthermore, the content may neither be copied nor made available to third parties for commercial purposes. Also subject to copyright are the images and videos that were made available to WAGO Kontakttechnik GmbH & Co. KG by third parties."